

**SPECIFICATIONS**

Electrical Ratings	200mA @ 36VDC
Electrical Life	20,000 cycles typical
Contact Resistance	< 50 mΩ initial
Actuation Force	300 +/- 100gF
Actuator Travel	2 +/- .25mm
Dielectric Strength	1000Vrms min
Insulation Resistance	> 100MΩ min
Operating Temperature	-40°C to 85°C
Storage Temperature	-40°C to 85°C



**MATERIALS ← RoHS COMPLIANT**

Actuator	PC – Polycarbonate
Housing	6/6 Nylon
Cover	6/6 Nylon
Contacts	Phosphor Bronze, Silver Plated
Terminals	Brass, Silver Plated

**ORDERING INFORMATION**

<b>1. Series:</b>	<b>DS</b>	<b>1</b>	<b>C</b>	<b>R</b>	<b>G</b>
DS					
<b>2. Switch Function:</b>					
1 = SPST N.O.					
2 = DPST N.O.					
<b>3. Cap Option:</b>					
N = No Cap					
C = With Cap					
<b>4. LED Color:</b>					
Blank = No LED					
R = Red					
G = Green					
Y = Yellow					
B = Blue					
<b>5. Second LED Color: **For Bicolor LED option</b>					
Blank = No Second LED Color					
R = Red					
G = Green					
Y = Yellow					
B = Blue					

**DIMENSIONS**

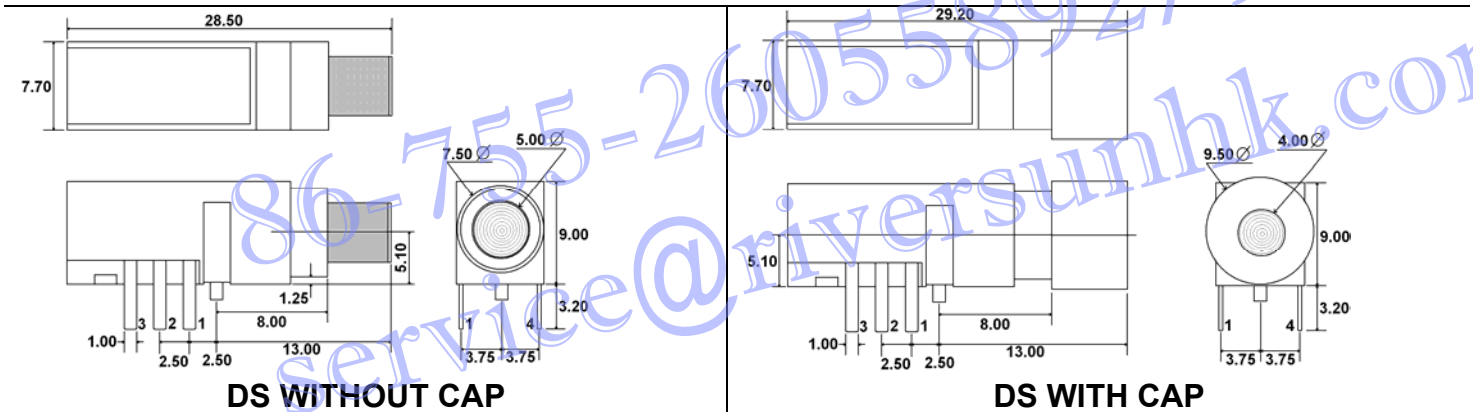

**SCHEMATICS**

**PC LAYOUTS**

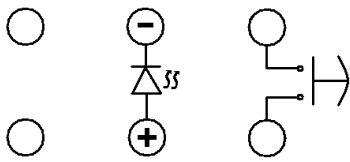

**DS1 WITH LED**

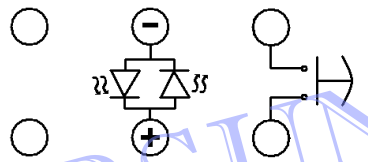

**DS1 WITH BICOLOR LED**

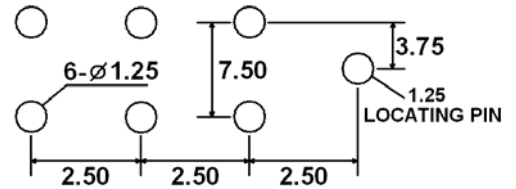

**BOTTOM VIEW**

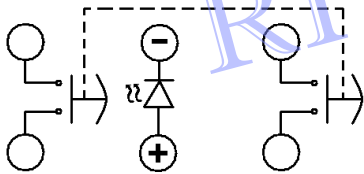

**DS2 WITH LED**

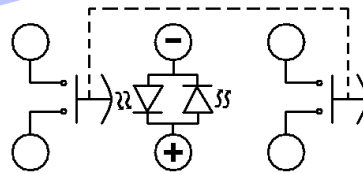

**DS2 WITH BICOLOR LED**

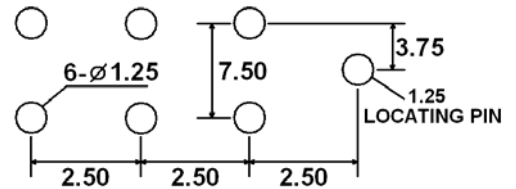

**BOTTOM VIEW**

**LED SPECIFICATIONS**

LED Ratings		Value				Units
		R	G	Y	B	
Reverse Voltage	$V_R$	5	5	5	5	V
Forward Current (avg)	$I_F$	15	30	20	30	mA
Forward Current (peak)	$I_{FS}$	160	120	80	100	mA
Reverse Current $V_R = 5V$	$I_R$	10	10	10	10	$\mu A$
Power Dissipation	$P_T$	40	100	60	120	mW
Operating Temperature	$T_A$	-40~ +85				$^{\circ}C$
Storage temperature	$T_{STG}$	-40~ +85				$^{\circ}C$
Forward Voltage (typ.), $I_F = 20mA$	$V_F$	1.7	1.7	1.7	3.5	V
Forward Voltage (max.), $I_F = 20mA$	$V_F$	2.6	2.6	2.6	4.0	V
Capacitance, $V_F = 0V, f = 1MHz$	CO	15	20	20	100	pF
Wavelength at Peak Emmission, $I_F = 20mA$	$\lambda_P$	697	565	585	470	nm
Spectral Line Half-Width, $I_F = 20mA$	$\Delta\lambda$	90	30	35	25	nm
Luminous Intensity, $I_F = 20mA$	LI	4.2	20	8.0	450	mcd
Viewing Angle	$\Theta$	50	50	50	30	Deg

86-755-26055892/93/51  
service@riversunhk.com