

SPECIFICATIONS

Electrical Ratings	100mA @ 30VDC
Electrical Life	100,000 cycles typical
Contact Resistance	< 50 mΩ initial
Actuation Force	180 +/- 50gF
Actuator Travel	1.5 mm to lock 2.5 mm full travel
Dielectric Strength	1000Vrms min
Insulation Resistance	> 100MΩ min
Operating Temperature	-40°C to 85°C
Storage Temperature	-40°C to 85°C



MATERIALS ←RoHS COMPLIANT

Actuator	Acetal
Housing	6/6 Nylon
Cover	Acetal
Latching Pin	Stainless Steel
Spring	Stainless Steel
Contacts	Phosphor Bronze, Silver Plated
Terminals	Brass, Silver Plated

ORDERING INFORMATION



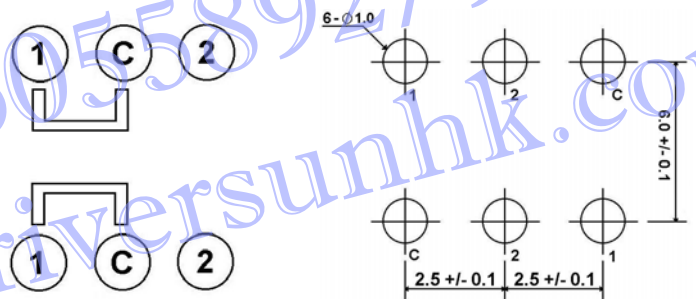
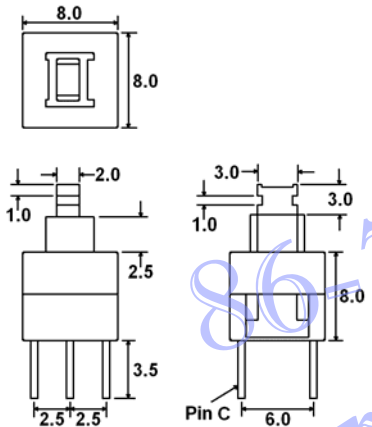

1. Series:	LP2202	F180	L	C022
2. Actuation Force:	F180 = 180gF			
3. Latching:	N = Non-latching L = Latching			
4. Cap Options:	Blank = No Cap C01 C02 C03			
Cap Colors:	**See Cap Options for color availability			

DIMENSIONS

SCHEMATIC & PC LAYOUT

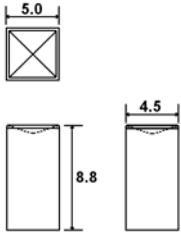

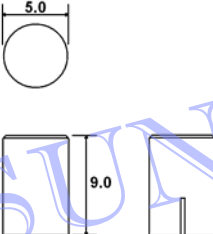
CAP OPTIONS

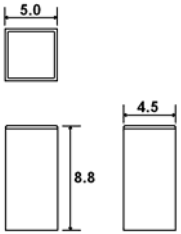
  <p>C01 1 = White, 2 = Black, 3 = Red, 9 = Light Gray Contact Factory for other available colors</p>	  <p>C02 1 = White, 2 = Black, 3 = Red, 9 = Light Gray Contact Factory for other available colors</p>	  <p>C03 1 = White, 2 = Black, 3 = Red, 9 = Light Gray Contact Factory for other available colors</p>
---	---	---

86-755-26055892/93/51
 service@riversunhk.com