

SPECIFICATIONS

Electrical Ratings	100mA @ 30VDC
Electrical Life	100,000 cycles typical
Contact Resistance	< 50 mΩ initial
Actuation Force	140 +/- 50gF
Actuator Travel	1.0 mm to lock 1.8 mm full travel
Dielectric Strength	1000Vrms min
Insulation Resistance	> 100MΩ min
Operating Temperature	-40°C to 85°C
Storage Temperature	-40°C to 85°C



MATERIALS ←RoHS COMPLIANT

Actuator	PBT
Housing	PBT
Cover	PBT
Latching Pin	Stainless Steel
Spring	Stainless Steel
Contacts	Phosphor Bronze, Silver Plated
Terminals	Brass, Silver Plated

ORDERING INFORMATION

1. Series:	LP2283	F140	N
2. Actuation Force:	F140 = 140gF		
3. Latching:	N = Non-latching L = Latching		
4. Cap Options:	Cap Colors: Blank = No Cap C01 C02 C03 C05 **See Cap Options for color availability		



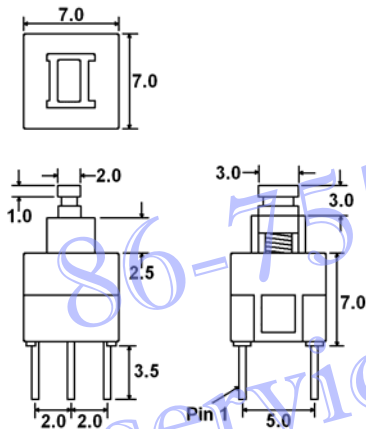



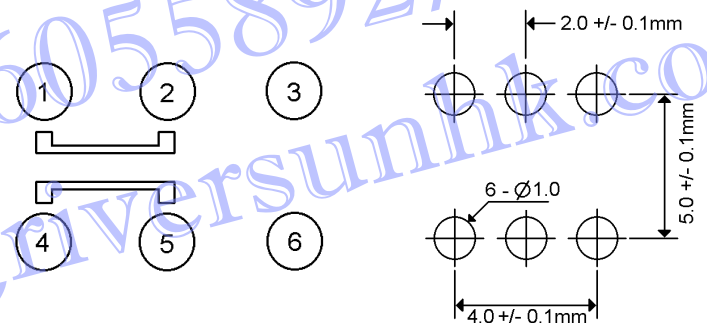



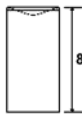

DIMENSIONS

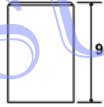
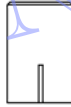

SCHEMATIC & PC LAYOUT

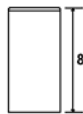

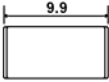
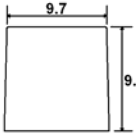
CAP OPTIONS

    <p>C01_ 1 = White, 2 = Black, 3 = Red, 9 = Light Gray Contact Factory for other available colors</p>	    <p>C02_ 1 = White, 2 = Black, 3 = Red, 9 = Light Gray Contact Factory for other available colors</p>	    <p>C03_ 1 = White, 2 = Black, 3 = Red, 9 = Light Gray Contact Factory for other available colors</p>
    <p>C05_ 1 = White, 2 = Black, 3 = Red, 9 = Light Gray Contact Factory for other available colors</p>		

86-755-26055892/93/51
 service@riversunhk.com